

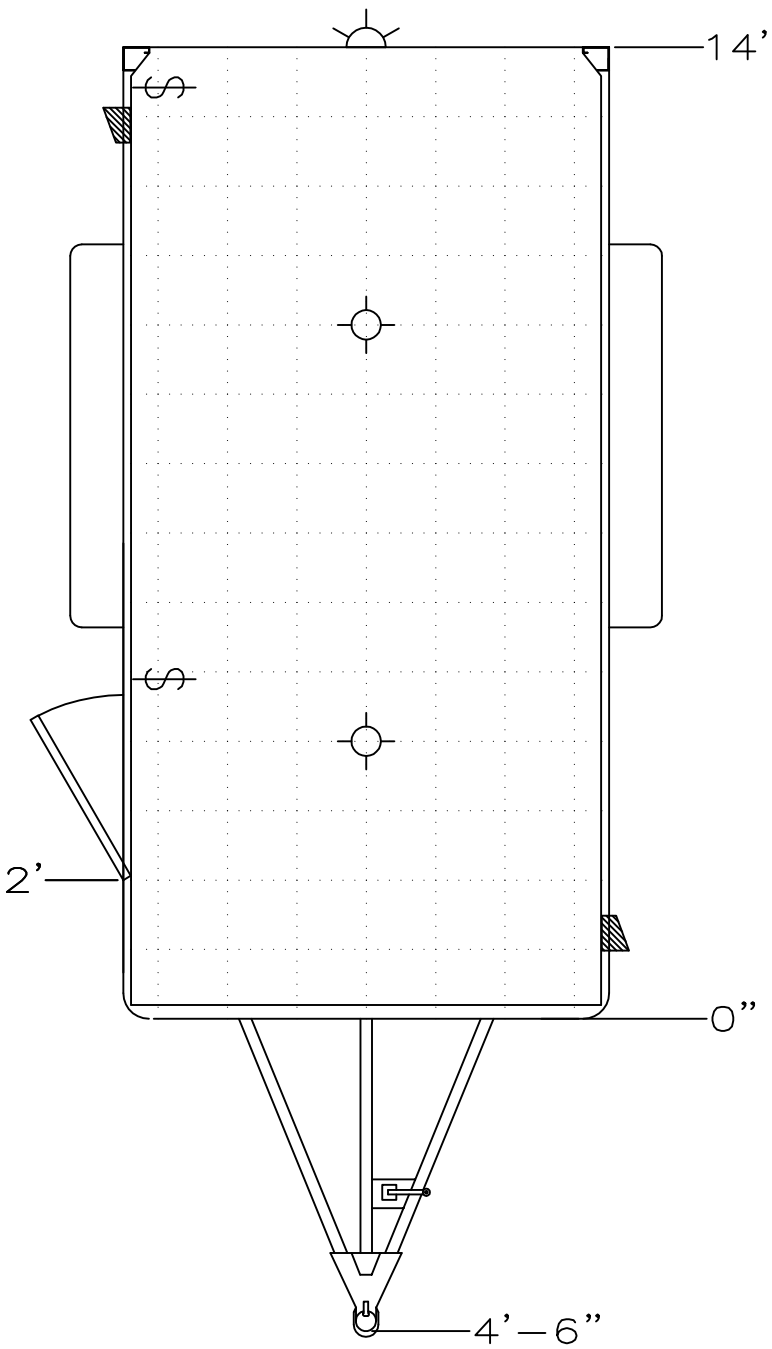













CUSTOMER:

DATE:

MODEL: TM714TA



KEY:

| NOTES | 12 VOLT ELECTRICAL | 110 VOLT ELECTRICAL | ROOF VENTS | X - D RING E - E TRACK T - TIRE T/C - TIRE COMPARTMENT | <p>PROPRIETARY AND CONFIDENTIAL</p> <p>THE INFORMATION CONTAINED IN THIS DRAWING IS THE SOLE PROPERTY OF BRAVO TRAILERS LLC. NO PART OR AS A WHOLE WITHOUT THE WRITTEN PERMISSION OF BRAVO TRAILERS LLC IS PROHIBITED.</p>  |
|-------|--|---|--|---|--|
| | <ul style="list-style-type: none">  - STANDARD LED DOME LIGHT  - 4" ROUND LED DOME LIGHT  - LOADING LIGHT  - WALL SWITCH | <ul style="list-style-type: none">  - PANEL  - MOTOR BASE PLUG  - WALL SWITCH  - USB RECEPT  - 15 AMP RECEPT  - 20 AMP RECEPT  - GFI RECEPT | <ul style="list-style-type: none">  N/P = NON POWERED 12V = 12 VOLT POWERED 110V = 110 VOLT POWERED A/C = AIR CONDITIONER W/F = WIRE & FRAME | | |